

THERMYLENE®

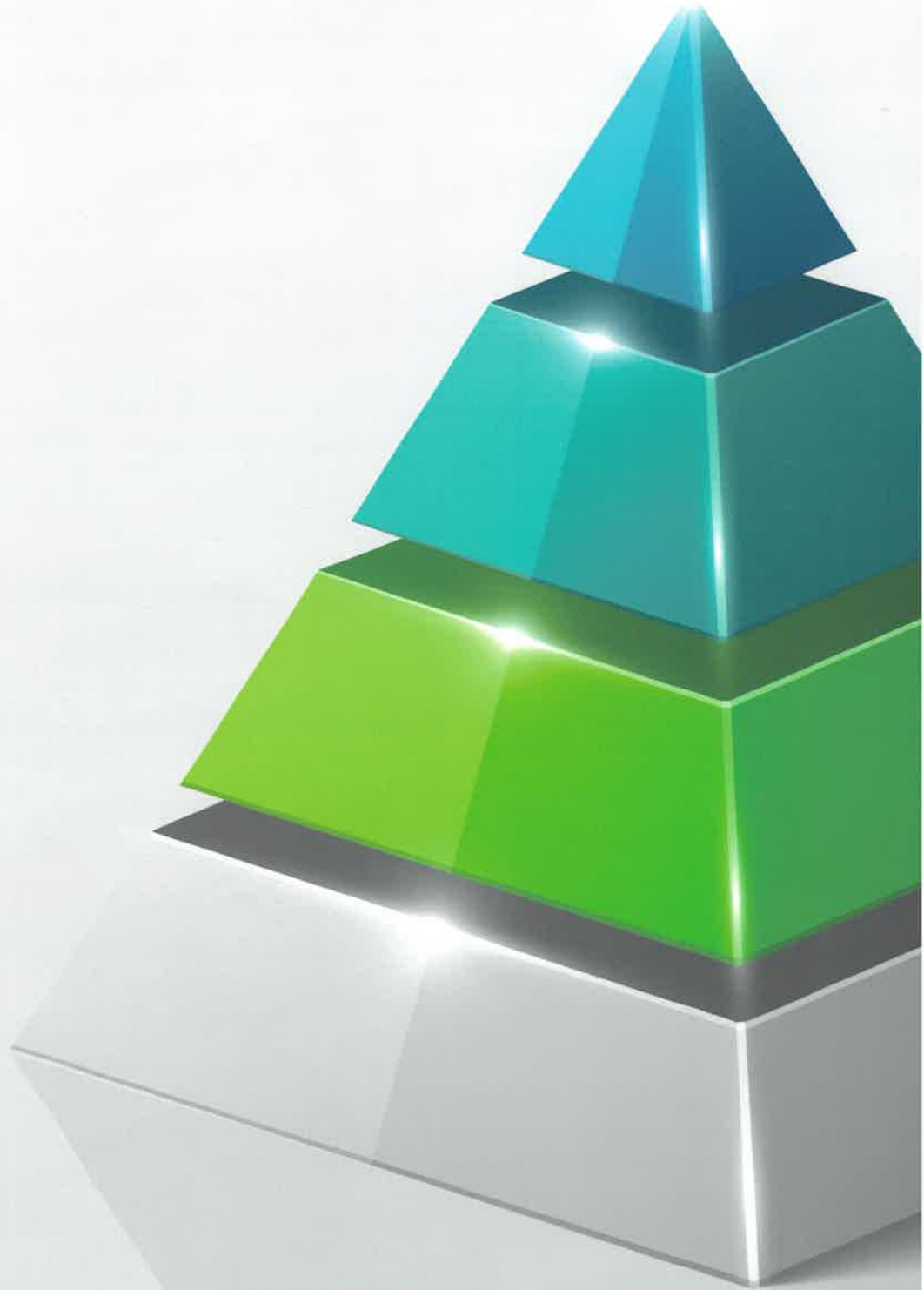

Engineered Polypropylene Compounds

AsahiKASEI

Innovative Polypropylene Compounds for Enabling Applications

What is Thermylene®?

Thermylene® is a series of engineered polypropylene compounds designed to enable application performance requirements at an optimal value. The enhanced properties of these polymers yield an extremely attractive cost/performance balance when compared to traditional engineering thermoplastics. Thermylene® is a globally established brand that is currently in production in multiple locations throughout North America, Europe and Asia.

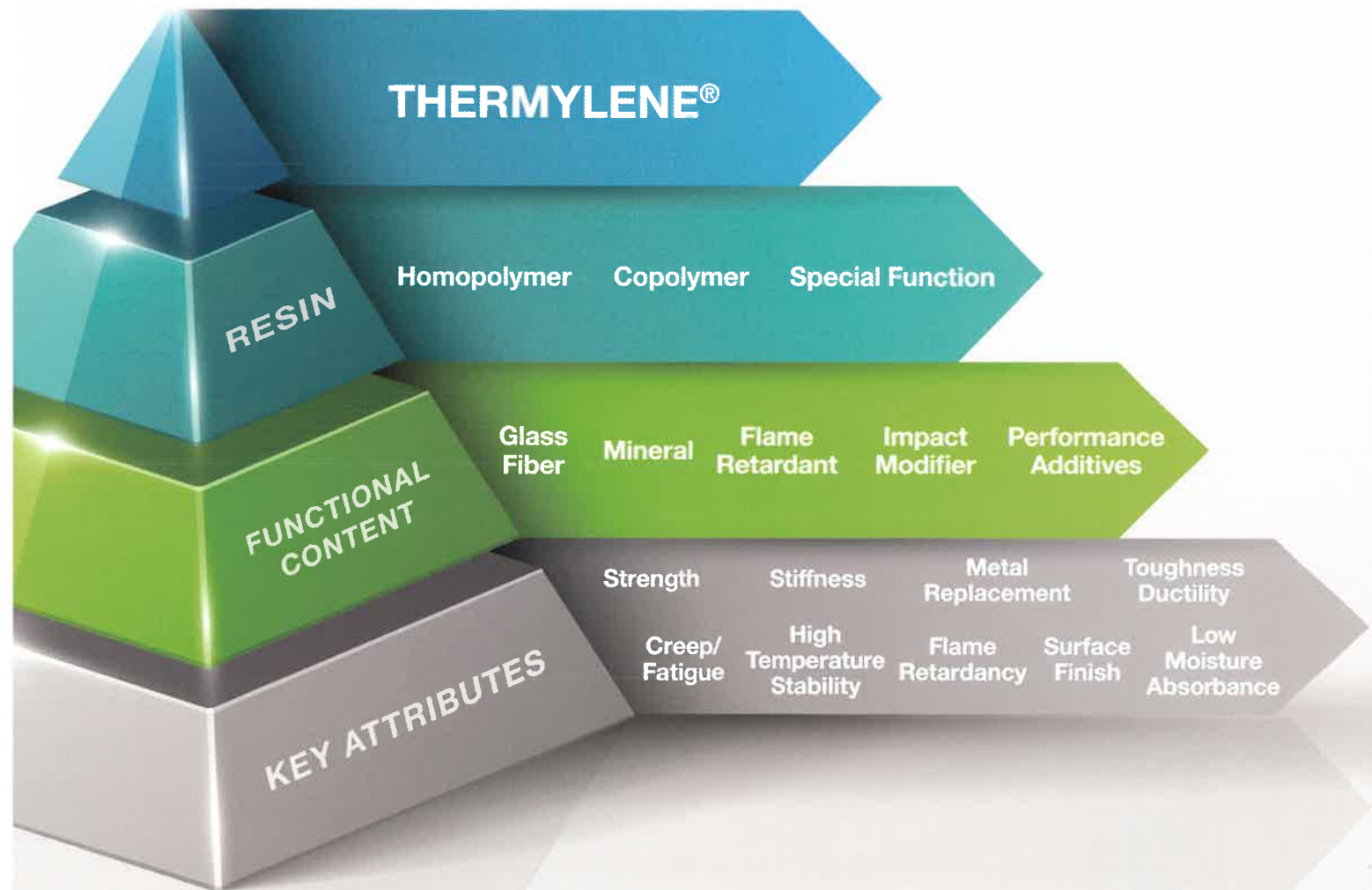

Key Attributes:

- Available in all varieties of fillers and reinforcements
- Portfolio includes high performance chemically coupled glass reinforced polypropylene compounds
- Enhanced tensile strength and stiffness
- Enhanced toughness
- Underhood temperature performance
- Higher creep resistance
- Excellent chemical resistance
- R&D focused on innovation with patented technology
- Custom designed formulations
- Global technical service support
- Automotive and regulatory approved grades

A Broad Range of Product Applications Across Diverse Industries

Automotive Electric

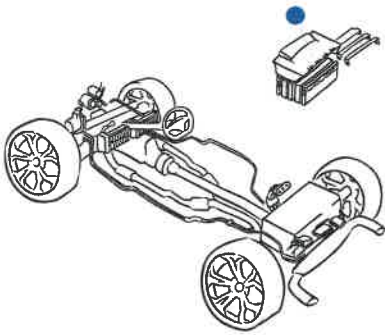

Automotive Exterior

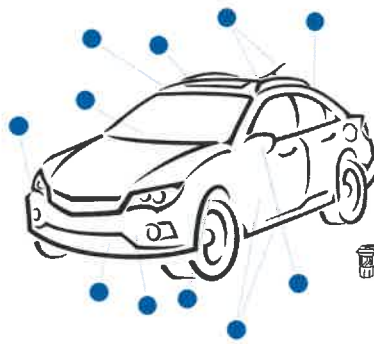

Automotive Interior



Home Electric

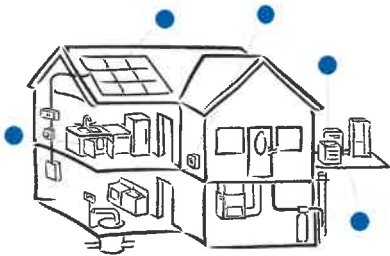

Home Water



Furniture



Automotive Underhood

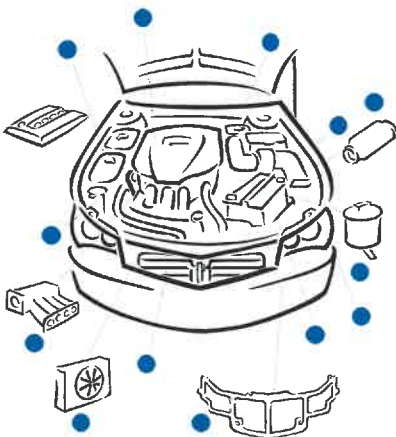

Trucking



● Thermylene® Applications

Technology Evolution

GF-30 Comparison

Property	Specification	Units	Thermylene P6-30FG	Thermylene P7-30FG	Thermylene P8-30FG	Thermylene P9-30FG	Thermylene P10-30FG	Thermylene P11-30FG
Filler		%	30	30	30	30	30	30
Tensile Strength	ISO 527	MPa	85	91	98	102	106	110
Flexural Modulus	ISO 178	MPa	5900	6500	6600	6900	6600	6900
Notched Charpy	ISO 179	kJ/m ²	8.5	10	10	9	10	10
HDT @ 1.8 MPa	ISO 75	°C	142	146	148	150	152	154

Performance Improvement @ Constant Density of ~1.14 g/cm³

Performance Evolution @ Constant Density

PP-30GF Strength, MPa

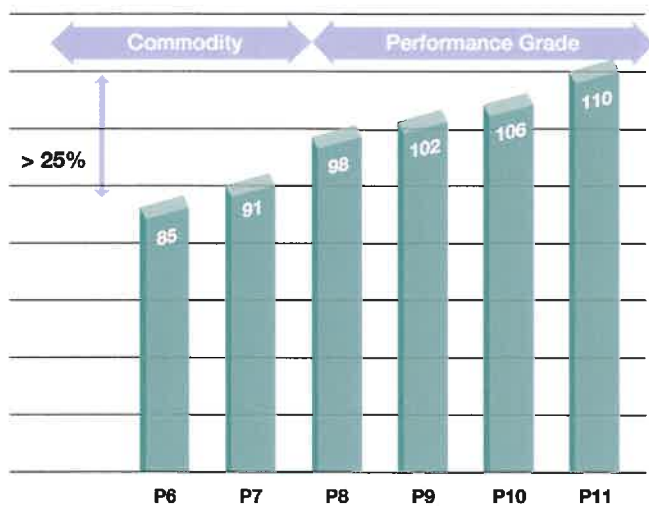

Nominal Wall Thickness Reduction Potential

(Represents mm units; Calculated for 10mm part width; 2550 N load force)



Because we cannot anticipate or control the many different conditions under which this information and our products may be used, we do not guarantee the applicability or the accuracy of this information or the suitability of our products in any given situation. Users of our products should make their own tests to determine the suitability of each product for their particular purposes. Further, except as we may specifically state in the terms of sale for each particular transaction, we make no warranty of merchantability or fitness for a particular purpose, whether express or implied. Also, statements concerning the possible use of our products are not intended as recommendations to use our products in the infringement of any patent.

Modulus Spectrum

Thermylene for High Stiffness and Weight-Reduction (Typical Modulus, Mpa)

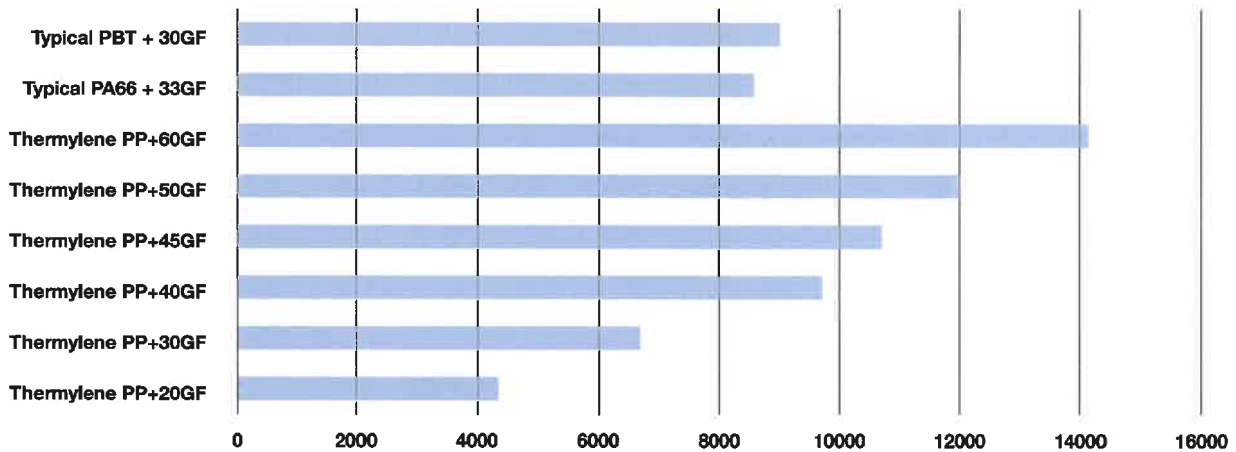

Computer Aided Engineering (CAE)

Asahi Kasei supports the application success of our customers with computer aided engineering (CAE) support. This support includes, but is not limited to, material testing, material processing, molding, mold flow analysis, part design and structural finite element analysis (FEA) capabilities. All these testing methods are available on global scale.

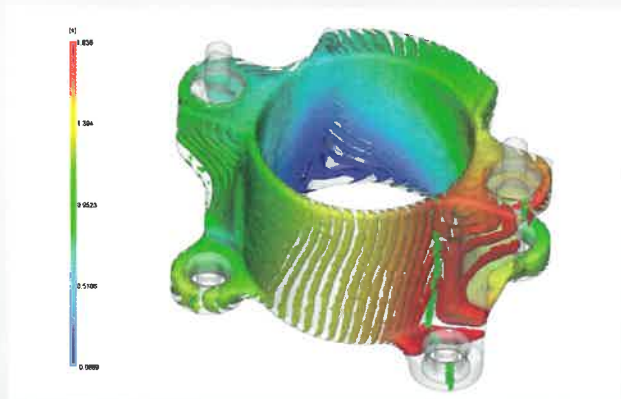
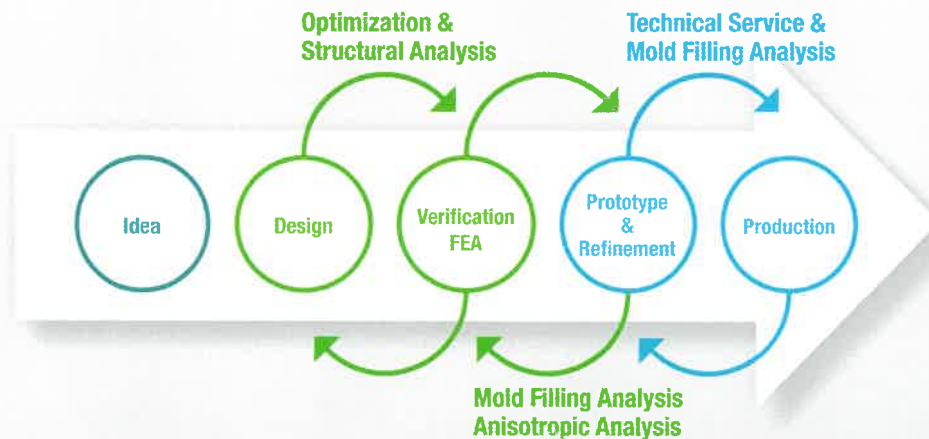

Simulation Output Example



Lab Capabilities

Specialty Grades

Thermylene® Soform™

Soform™ is developed as a soft-touch haptics grade that provides structural soundness. It is tailored for weathering and enhanced scratch resistance in your applications. Soform™ can help eliminate need for soft-touch paints, over-molding with soft materials, while also being able to be directly injection molded.



Thermylene® Element™

Element™ is designed to provide your applications with a hydrophobic part surface to help repel ice and water build-up in cold conditions. Element™ can also help repel surface stains such as coffee, sunscreen, juice and lotion, to help your application have a stain-free and longer service life. It can be designed with tailored mechanical properties, weathering and scratch resistance.



Thermylene® Stress Whitening Prevention™ (SWP)

The Thermylene® Stress Whitening Prevention™ (SWP) is a patented technology that has been designed to eliminate stress whitening defects that occur in molded applications. This technology was initially designed for furniture and consumer applications but has been perfected to also improve aesthetics in automotive interiors. SWP is available in various configurations to meet the mechanical requirements of various applications.



Thermylene® Thermoforming Grades

The Thermylene® family of thermoforming grades are meant for use in deep draw thermoforming applications. These materials have very high melt strength compared to competitive materials and wide processing windows. Grades can be designed according to your application with varying levels of stiffness, gloss and superior UV and scratch resistance.



Awards and Recognition

Thermylene® Door Module



Thermylene® Tonneau Cover Assembly



Thermylene® Integrated Sunroof Module



Thermylene® Fan Shroud



Thermylene® Mirror Bracket



Thermylene® Wiper Components



Thermylene® Truck Storage Box

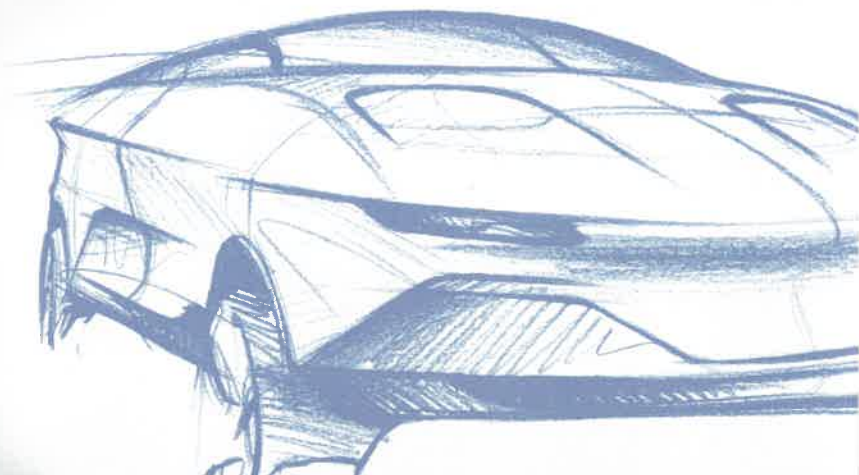

Plastics Resources Around the Globe



Thermylene® Resources:

United States of America and Mexico

Asahi Kasei Plastics North America
<https://www.akplastics.com/>
+1-517-223-2000

Japan

Asahi Kasei Advance Corporation
<https://www.asahi-kasei.co.jp/asahi>
+81-3-5404-5043

Thailand

Asahi Kasei Advance Thailand Co., Ltd
<http://www.asahi-kasei.co.th/index.php/en/>
+66-2258-4870

European Countries

Asahi Kasei Europe GmbH
<https://www.asahi-kasei.eu/>
+49-(0)211-8822-030

China

Asahi Kasei Plastics Shanghai Co., Ltd.
<https://www.asahi-kasei.cn>
+86-(0)21-6391-5252

India

Asahi Kasei India Pvt. Ltd.
<https://asahi-kasei.in/>
+91-22-6710-3962

AsahiKASEI